



Principios generales de arduino.

fedoraTM *Electronic Lab*

Arduino.

Kiara Navarro
sophiekovalevsky@fedoraproject.org

3w.clase911.com

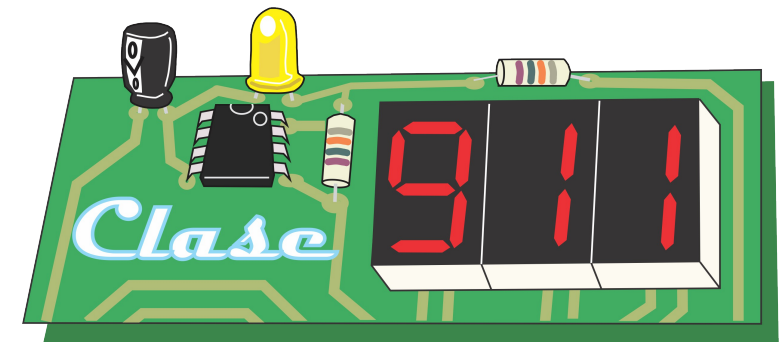



Arduino

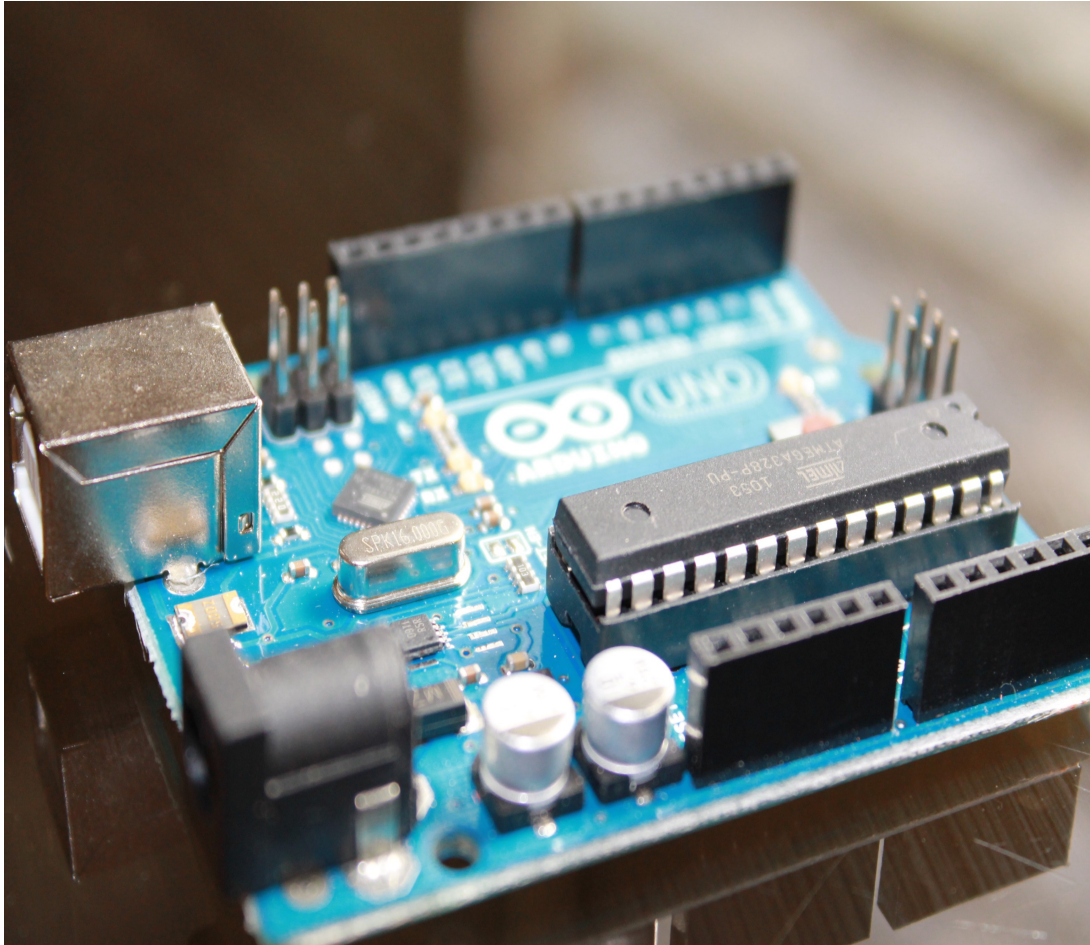

- Es una plataforma de hardware libre de fácil uso que permite la interacción entre componentes electrónicos y software.
- Dirigido a personas interesadas en aprender de electrónica, diseñadores, artistas.
- Posee una gran cantidad de librerías que permiten aumentar la velocidad de diseño.



Tipos de arduino



Circuitos analógicos

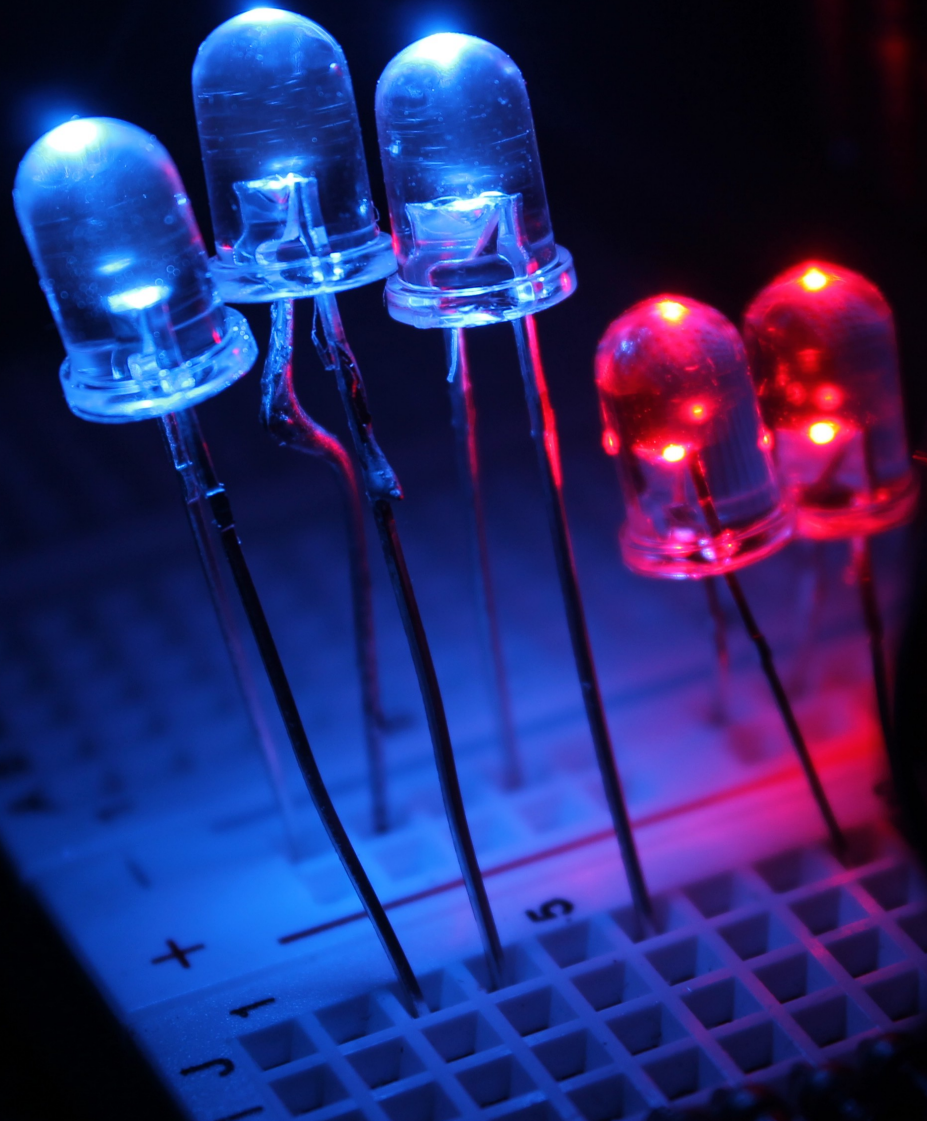



Decodificador 7 segmentos

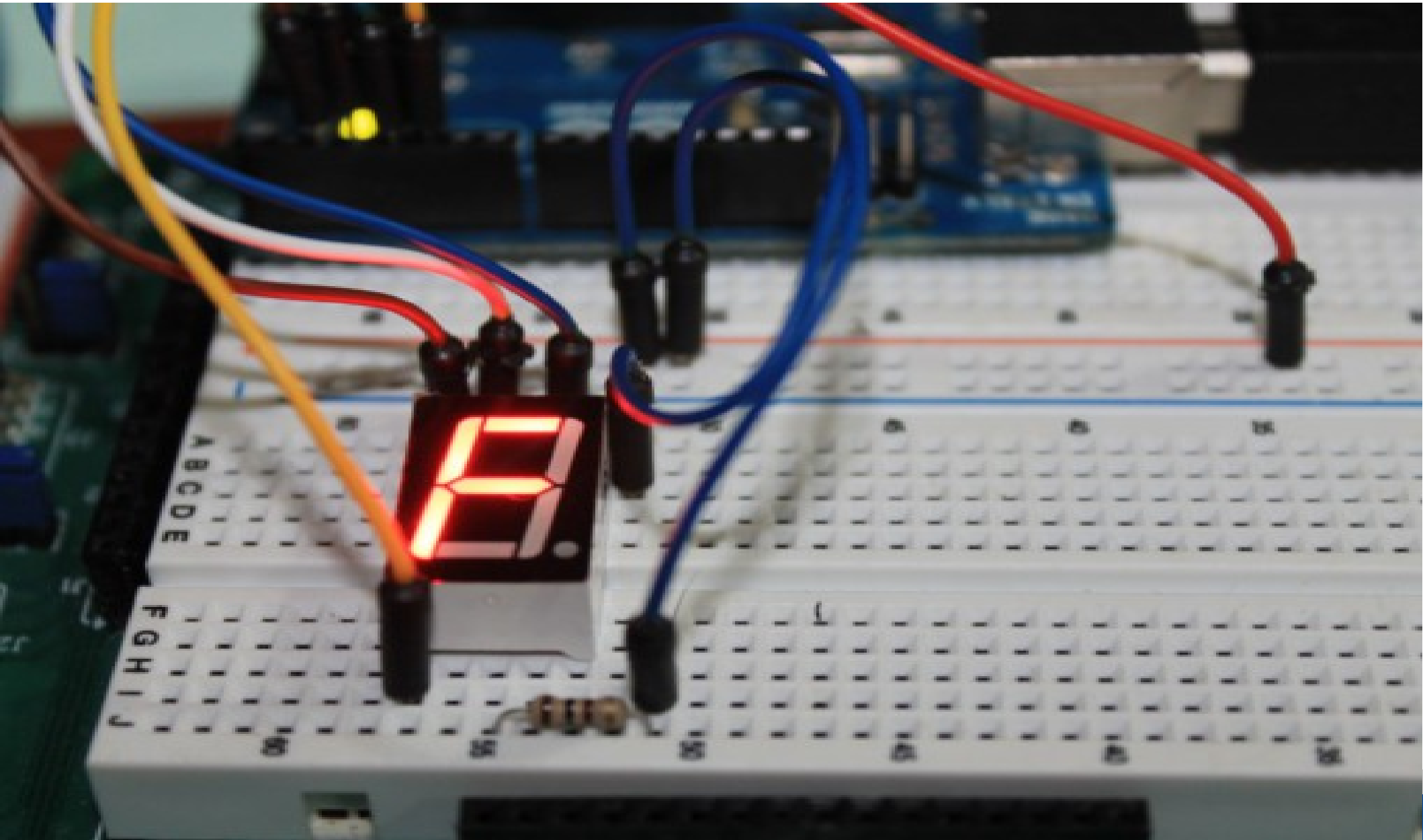

Led RGB



Cubo de leds 3x3x3

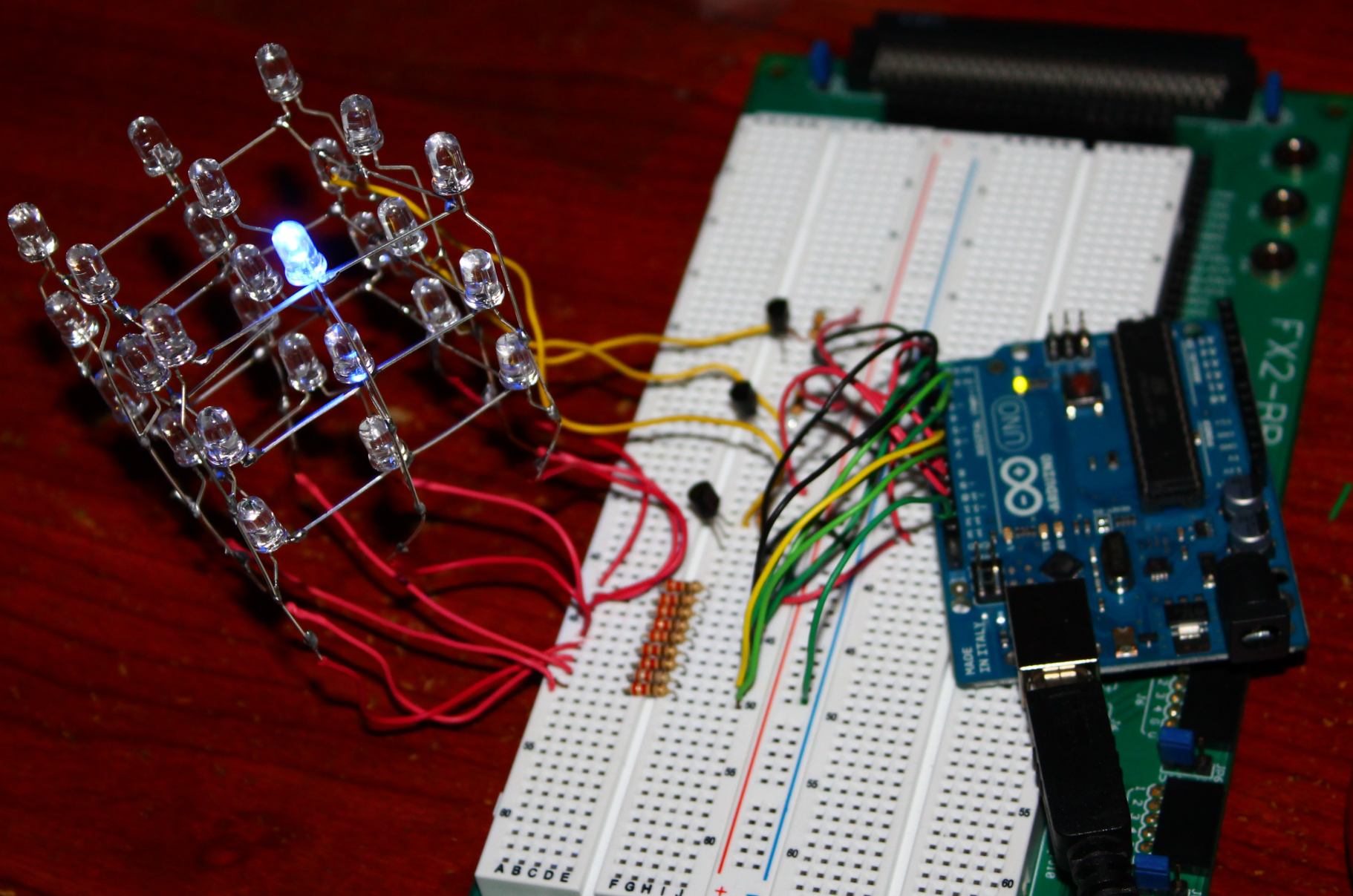



Módulo de RFID

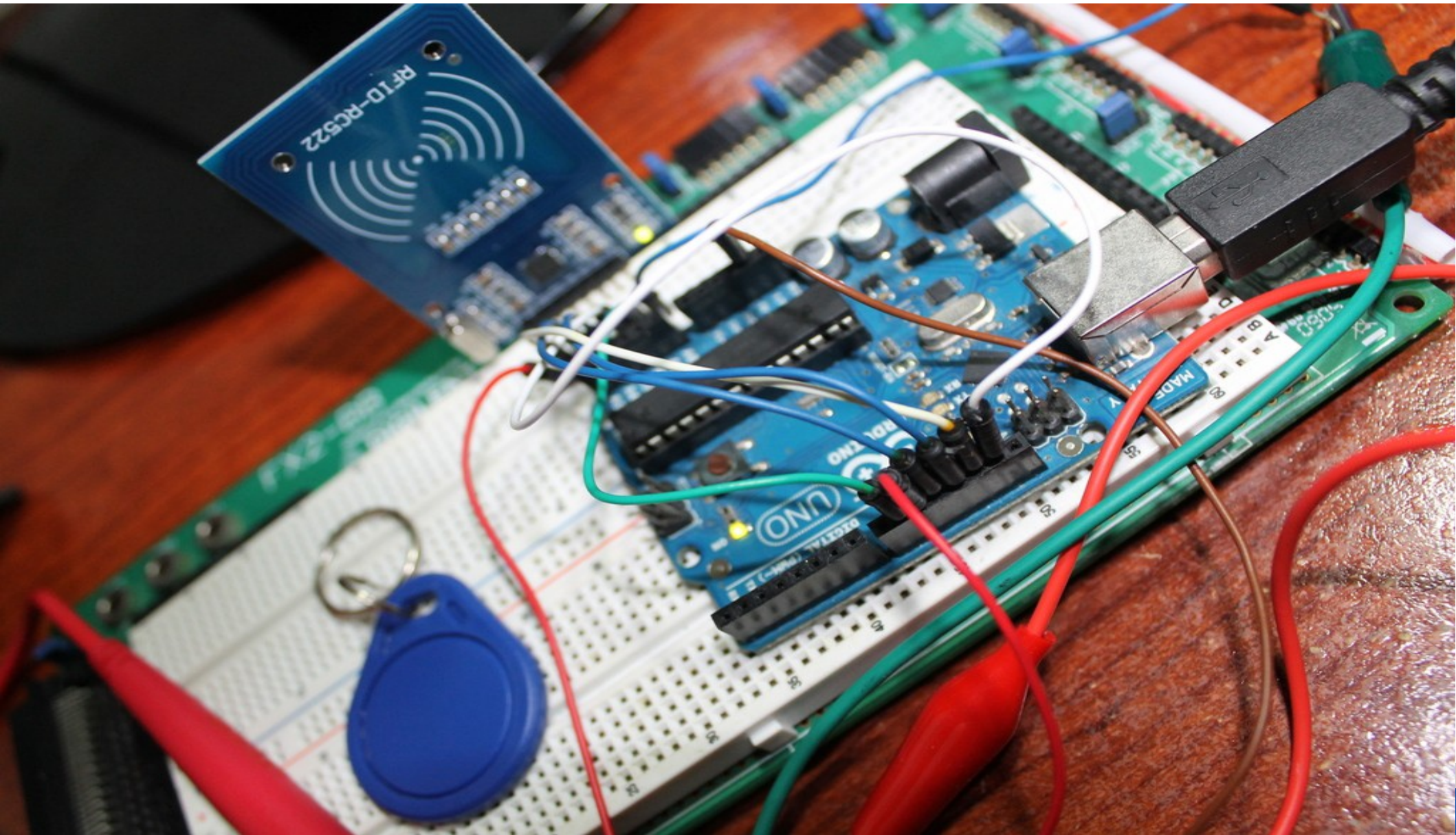



Montaje de un LCD

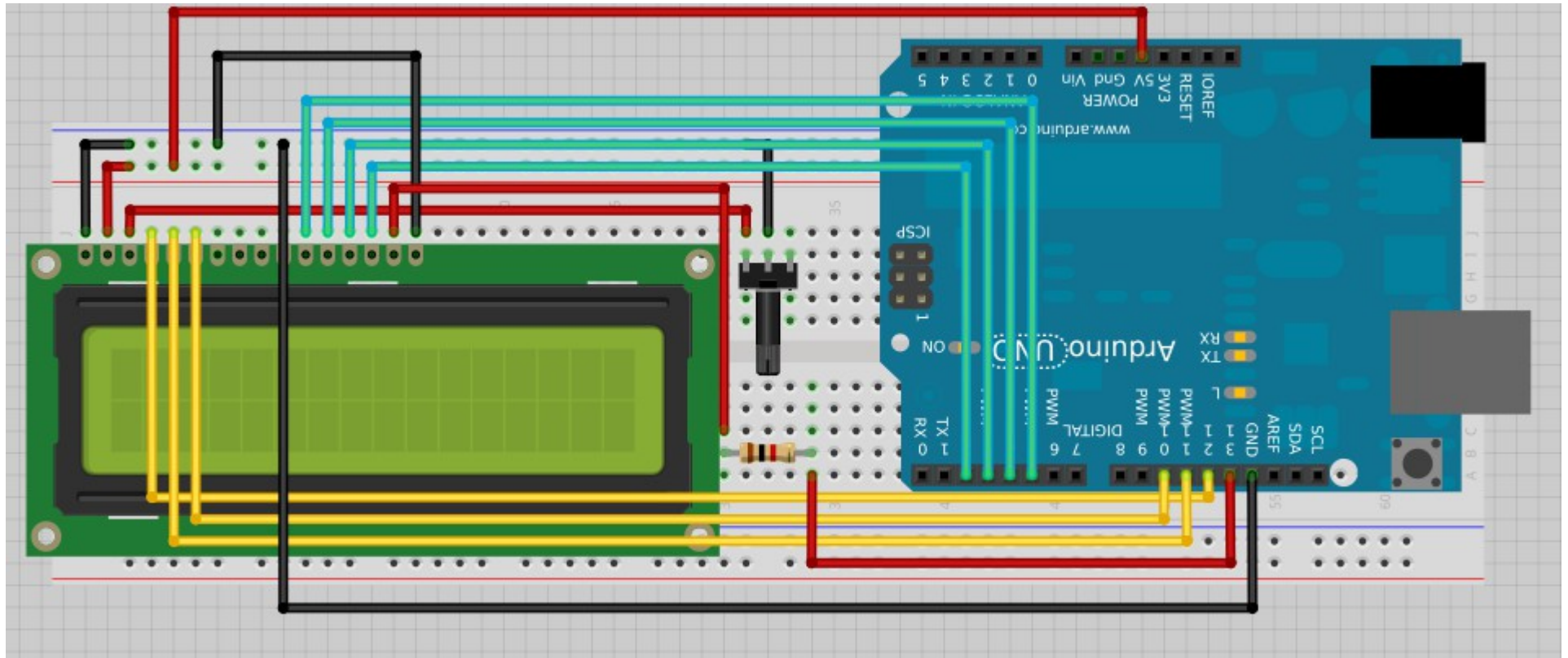



Shields

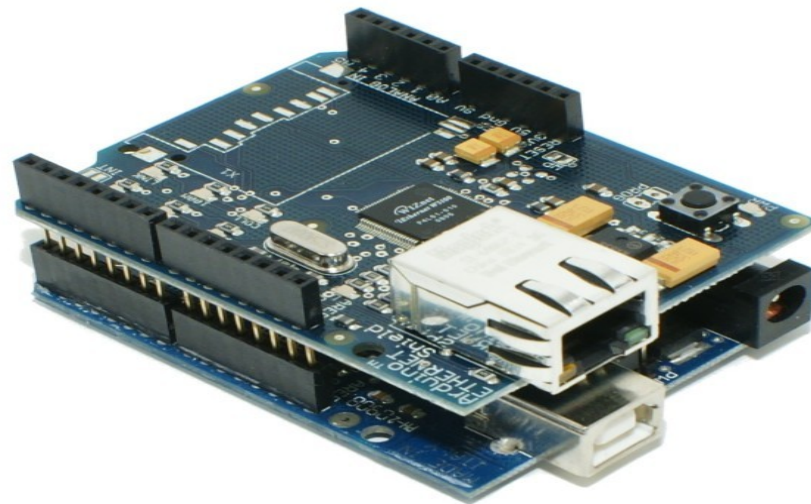

The **fedora**[™]  electronic lab team =)

